

6V  
975  
.A1  
P3

November/December 1988

Our 63rd Year

SERIALS

DEC 20 1988

MICHIGAN STATE UNIVERSITY  
LIBRARIES

# A PATCH of GREEN



SEASON'S GREETINGS



PERIODICAL

OFFICIAL PUBLICATION OF THE MICHIGAN & BORDER  
CITIES GOLF COURSE SUPERINTENDENTS ASSOCIATION

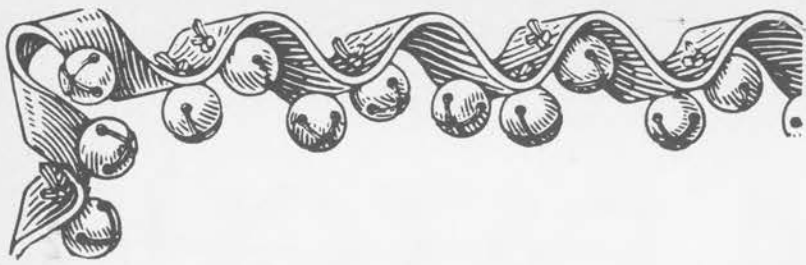

# Season's Greetings



and Best Wishes  
for the Coming Year

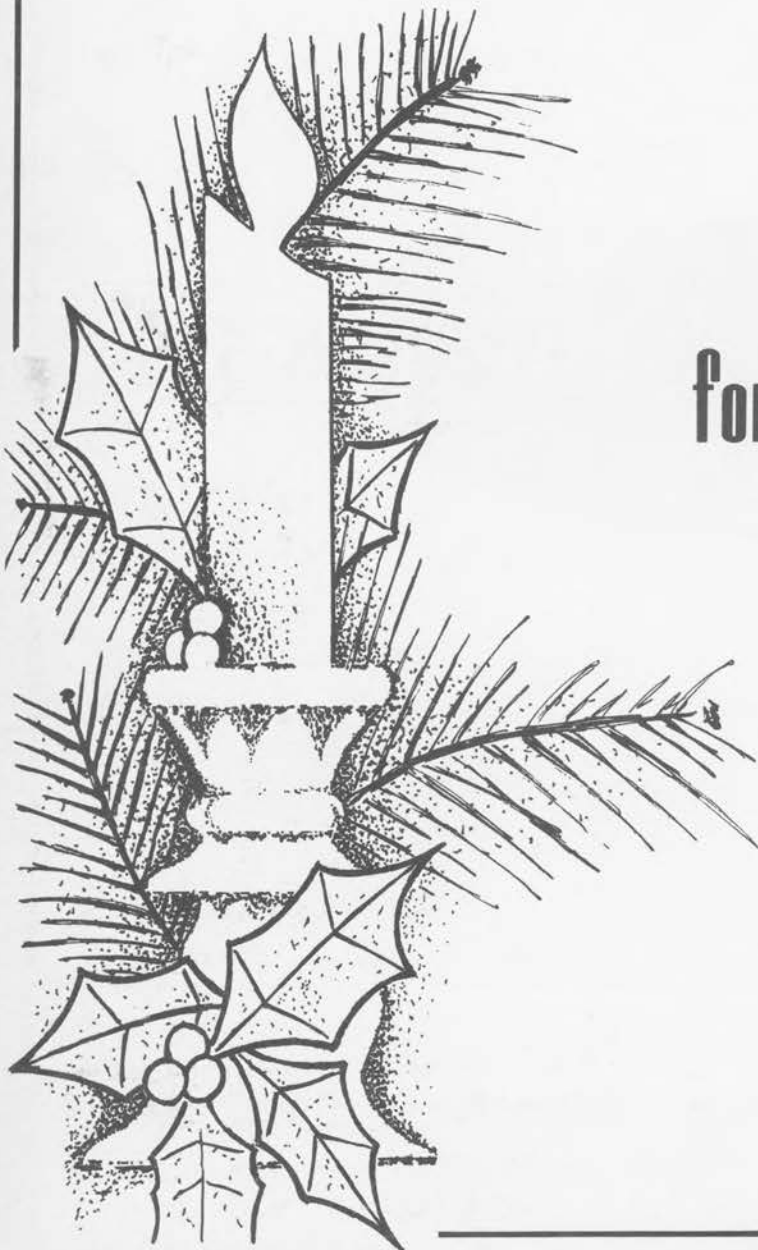

---

from the  
Editor and Publisher

---



## PRESIDENT'S MESSAGE

Another year is coming to a close. None of us will forget 1988 for a long time. With summer heat and drought and autumn rains, we can hopefully look forward to a slower winter season.

On October 18, we had our annual business meeting at Maple Lanes Golf Club. I would like to thank Peter Roehl and Greens Superintendent Paul Lolbe for their hospitality.

We had two director changes. Newly elected were Jim Eccleton and Steve Kolongowski. Welcome aboard guys. The two members leaving were Jim Timmerman and Roger Gill. Jim Timmerman, who was the Membership Chairman, increased the membership during his term. Thank you, Jim for your hard work. Roger Gill served as Education Chairman. Thank you, Roger for setting up all those meetings and speakers, a job well done.

There was a dues increase voted on and passed. New dues will be: Class A \$40.00, B \$40.00, F \$70.00, S\$15.00, D\$35.00.

The Executive Board had a meeting with the G.A.M. Greens Committee to discuss our spring seminar. Tom Mason will be Chairman. If there are

any members that would like to have a topic discussed, please contact Tom. There are also some clubs that in the past have donated the dollar per member to the M.T.F., but for some reason this year did not. If this has been an oversight, would you superintendents check with your clubs to see that they make this important donation to M.T.F.

We thank those of you that did donate to the M.T.F., G.A.M., and the MBCGCSA.

As the year does come to an end, I want to remind all of you of our Annual Christmas Party. This year it is at Detroit Golf Club, Friday, December 9. See you all there.

Seasons Greetings to you and your families.

Charles Gaige  
President, MBCGCSA

MERRY CHRISTMAS



HO! HO! HO!



### "A PATCH OF GREEN"

Published Bi-Monthly by the  
MICHIGAN AND BORDER CITIES GOLF  
COURSE SUPERINTENDENTS ASSOCIATION

President  
CHARLES GAIGE

Vice-President  
TOM MASON

Secretary/Treasurer  
JON MADDERN

#### Directors

KEN DeBUSSCHER  
ROGER GILL  
JIM TIMMERMAN

ED HEINEMAN  
JAY DeCAMP  
GARY THOMMES

President Emeritus  
KEVIN DUSHANE

Editor  
TED WOEHRLE

Printed at  
BLAKEMAN PRINTING CO.,  
Fraser, Michigan  
(313) 293-3540

# Wm. F. Sell & Son, Inc.

SINCE 1923

RENTAL  
SALES - SERVICE



- ★ LOADERS ★ SWEEPERS
- ★ TRENCHERS ★ MOWERS
- ★ ROTARY CUTTERS
- ★ BACK HOE DIGGERS
- ★ BACK FILL BLADES
- ★ POST HOLE DIGGERS

### JOB TAILORED EQUIPMENT

COMPLETE LINE OF  
MATERIAL HANDLING  
& FARM EQUIPMENT

CALL

**282-5100**

16555 TELEGRAPH RD. - TAYLOR  
1 Mile South of Eureka

# GREEN IS THE COLOR OF GOLF

## HISTORY OF TURFGRASS MANAGEMENT

by William H. Bengueyfield,  
National Director, USGA Green Section

Early on, "green" has been the color of golf. In those early days when Dutch Traders called St. Andrew's (one of the world's largest trading markets and fairs in the 12th Century), the greens Linksland between harbor and town was ideally suited for Het Kolven - a popular ball and stick game from the Netherlands. The sandy coastal soils; the smooth wind-blown, rolling terrain and the soft, springy turf sustained by howling gales and gentle rains produced the Green Links. Natural too, were the pits of sand where sheep huddled for shelter, later to become hazards in the evolving game of "golf". Through the centuries the game cast its spell over these people and their land and eventually over the Earth.

These were simple times. The implements and balls of the day were as simple as the playing conditions crude. But the game persisted from the 12th Century on and by 1700, townfolk of St. Andrews called the narrow strip of land leading to the harbor and the sea "The Green". The course as known in this way for generations. There they would tee up with a handful of sand, hopefully drive the leather-wrapped feathered ball to the "fair-green" all the while keeping it out of the surrounding heather and mass of entanglements. Once on the fair-green, the next target was on the "play-green", a roughly prepared area with an equally roughly prepared hole in it. Sometimes the hole was so deep it took a long arm to retrieve the expensive ball. In early "golfe", the winner was determined by the number of holes he won in a contest, not by the total number of strokes taken during the round. Whether it be 5 or 15 was of minor concern, just as long as he "won the hole".

It was in 1754 - a rather recent date in the annals of golf, that the Royal and Ancient Golf Club was formed. Since the beginning of time, the Old Course has always belonged - and still does - to the citizens of St. Andrews. The Royal and Ancient Golf Club sought playing privileges there and in return worked out an agreement with the town fathers to pay for the maintenance of the course. This raises the interesting historical point, at least from the grass growers perspective. The Royal and Ancient was actually concerned with the care and maintenance of the turf on the Old Course fully 100 years before assuming responsibility for The Rules of Golf! In other words, course conditioning received very early attention. It was not until 1892 that the SR&A became the one and only governing body for the Rules (Unification of the American and British Codes of Rules did not take

place until 1951.).

By the end of the 1700's, the greenskeepers came into being. Not unlike today, they were charged with making things better for the golfer. From Horave Hutchinson's book, "British Golf Links", (1897), there appears this record from the Aberdeen Golf Links on July 6, 1820: "The secretary was instructed to pay Alexander Monroe at the rate of L4 (approximately \$15) per annum for taking charge of the Links and providing accommodation for the member's club boxes, and for that sum Monroe is to pay particular attention to keeping the holes in good order. If that was not bad enough, the above allowance was diminished in 1822 to L3, an alteration which may be regarded as an illustration of the well known prudence of the Aberdonians in financial matters."

Long before there was golf on the western side of the Atlantic, the Society of Golfers at St. Andrews (1832) decided to rebuild some of their "old greens". They enlarged them to the enormous and famous double greens of St. Andrews as we know them today!

And so the care of "The Green" had its beginning. The early golf professionals frequently became the greenkeepers as well. Neither job was known for its security even in those days. If a man could win at competitive golf it was all to his credit. But he would also be wise to know how to make club heads or golf balls or care for the course just in case.

Old Tom Morris, still considered the Grand Old Man of Golf and four times winner of the British Open, became greenkeeper of St. Andrews in 1865 and continued until 1904. He had two rules for his maintenance program: "Maire sound, Honeyman" was his cry for his assistant Honeyman to apply evermore topdressing of sharp sand to the greens and fairways in order to "maintain the character of the grass". His second rule was, "Nae Sunday Play. The course needs a rest if the golfers don't." As a tribute to Old Tom Morris for his care of the Old Course, the first patented hole cutter developed by Charles Anderson was presented to him in 1869.

Golf was now sinking its roots in this country and around the world. It caused people to take an increasing interest in grass. The first turf garden in America was established at Manchester, Connecticut in 1885 and the first turfgrass research was recorded in 1895 at Kingston, Rhode Island. Grazing sheep were still used in the early 1900's for mowing and nurturing the green cover of golf courses. But the

CONTINUED PAGE 25



**WILKIE**

**Turf Equipment Division, Inc.**

1050 OPDYKE RD. ● P.O. BOX 749

PONTIAC, MICHIGAN 48056 ● (313) 373-8800

WE AT WILKIE TURF EQUIPMENT DIVISION, INC. WOULD LIKE TO TAKE THE OPPORTUNITY DURING THIS SPECIAL TIME OF THE YEAR, TO EXTEND OUR HEARTFELT GRATITUDE TO THOSE OF YOU WHO HELPED TO MAKE THIS OUR BEST YEAR EVER. WITHOUT YOUR SUPPORT AND CONFIDENCE, WE WOULD NOT HAVE ENJOYED THE SUCCESS WE DID THIS YEAR. WE PLEDGE TO YOU, OUR VALUED CUSTOMERS, OUR CONTINUED EFFORT TO MAKE 1989 AN EVEN BETTER YEAR FOR ALL OF US.

THANKING YOU SINCERELY,  
WILKIE TURF EQUIPMENT DIVISION, INC.

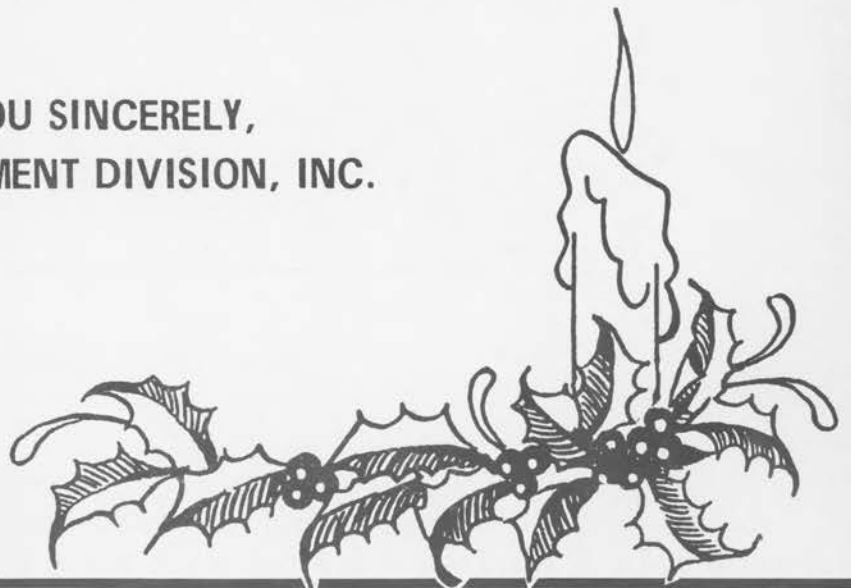

# EVANS SCHOLARS HOUSE

The Evans Scholars program recently reached a milestone in their 40 year history when the dedication of a new Chapter House took place on the campus of Michigan State University on September 17, 1988. Since 1948 hundreds of caddies from Michigan have received their college education through the efforts of the Western Golf Association through which the Evans Scholars Foundations functions.

When the building construction was completed the Evans Scholarship Committee solicited support from the local turfgrass Association to aid in the landscaping and sodding of the grounds. The MBCGCSA, through the efforts of Clem Wolfrom, Jim Eccleton, Chris Dayne, Bruce Wolfrom, Dwight Johanningsmeier, Fritz McMullen, John Mulvaney and Leo Pechette placed over 1,000 yards of bluegrass sod and produced an instant lawn for the house. Don Vidosh, from Green Acres Sod Farm supplied the sod, a fine gesture on his part. The sodbusters took time out of their busy schedules to provide the house with an instant lawn which included the raking and grading of the surface prior to sodding.

Others contributing their time and efforts were as follows:

Jim Scott, who provided the landscape plan.  
Kurt Kraley from Wilkie Turf Equipment Division

donated the irrigation equipment.  
John Green installed the irrigation system.  
Dan Bywalec of D & B Landscape donated the labor to plant the shrubs and trees and solicited nurserymen and supplies for all of the plant material such as mulch, flowers, etc. Dan put a lot of effort into this project.

Congratulations to all of you who put the time and effort into such a worthwhile project!

Kevin Dushane

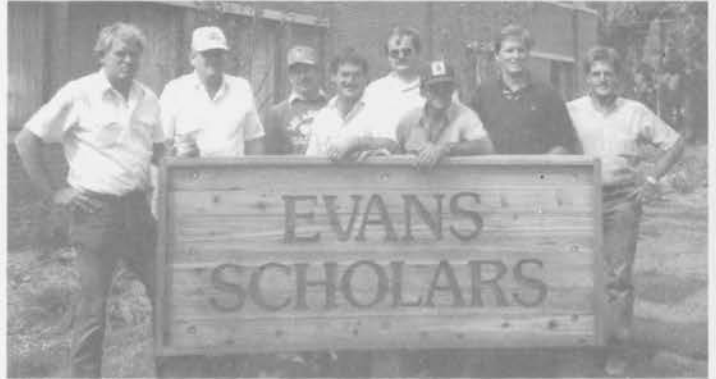

MBCGCSA CREW responsible for sodding Evans House lawn.



Our  
Best Wishes  
for the  
Holiday Season

DON, FRANK, MARTY,  
VIC, CEC, BUD, DAN,  
& PAULA

**BENHAM CHEMICALS**  
24800 N. Industrial Drive  
Farmington Hills, MI 48018  
313-474-7474  
1-800-482-6520 (MI ONLY)



# USGA TURFGRASS INFORMATION FILE

The USGA Turfgrass Information File (TGIF) provides computer-based bibliographic access to published materials relating to turfgrass research and management. The file is operated as a part of the Turfgrass Information Center at the Michigan State University Libraries. This USGA Turfgrass Research Committee project, in cooperation with the GCSAA, first became operational in August of 1984 and now includes more than 12,500 references, most of which (approximately 80%) include abstracts.

## FILE PURPOSE AND USES

As a file designed to support the efficient retrieval of research results, TGIF can be exploited to identify source documents discussing particular grasses (or cultivars, for that matter), cultural practices, agents, research methodologies, environmental conditions, etc., alone or in combination. It is also useful as a reference tool, for example, in tying together disease nomenclatural changes, surveying the state of knowledge on a particular insect pest (in the turf context), or quickly identifying who has conducted research on particular concern. In many cases, the abstracts themselves can provide management guidance based on summary conclusions. It is unbeatable at identifying that, "I can remember seeing an article on that about a year or so ago. . .," item, and quickly, too.

## FILE SCOPE AND CONTENT

To build the file, current published literature, from over 100 journals and publications, is selectively processed, including these kinds of sources:

**RESEARCH:** *Agronomy Journal*, *Plant Disease*, *Phytopathology*, *Crop Science*, *Canadian Journal of Plant Science*, *Journal of the Sports Turf Research Institute*, etc.

**PROFESSIONAL:** *USGA Green Section Record*, *California Turfgrass Culture*, *Golf Course Management*, *Greenmaster*, etc.

**TRADE:** *Landscape Management*, *Grounds Maintenance*, *ALA*, *SportsTURF*, etc.

In addition, online files and bibliographies from the National Agricultural Library, Commonwealth Agricultural Bureaux (U.K.), Biological Abstracts, etc. will be reviewed regularly to include materials from sources not usually reporting turf research.

Currently over 1200 different serial titles are represented in the database. Included are journals, conference proceedings, research annuals, newsletters, and extension bulletins in addition to the books,

papers, theses and dissertations, and special publications that make up the remainder of the file. Over 95% of the file entries have been published since 1968, reflecting the emphasis on recent materials.

Though significant results can be retrieved on most turf topics, it must be noted that the file continues to be "under construction" and cannot be considered "exhaustive" at this time. Coverage of the literature since 1980 is most complete, with the 1972-1979 period less well represented.

## THE SETTING

Designed to provide intellectual access to the existing O.J. Noer Memorial Turfgrass Collection at the Michigan State University Library, TGIF is but one element in a three part cooperative effort to develop a Turfgrass Information Center (TIC) at MSU. The O.J. Noer Collection, based on O.J. Noer's personal library and supplemented by gifts from many others, has now grown and become recognized as one of the best in the country. The O.J. Noer Foundation continues to provide support for the purchase of historical works and further additions to the collection from a variety of sources are encouraged on a continuing basis. The online index to the literature, TGIF, is sponsored by the USGA Turfgrass Research Committee. Both the collection and file are operated by the MSU Libraries, which finances and implements the collection development responsibilities.

## SEARCHING THE DATABASE

The database can be searched by a variety of means, including (as examples only): the presence of a word or words in a title, abstract, or as an assigned index term; author or authors; journal which the item appeared in; time period of publication, by year or years; refereed sources only, or any combination of qualifiers. The database is constructed within the STAR Database Software, which features many search capabilities found only on mainframe-mounted and commercially-operated databases. This flexibility, combined with the speed of execution, makes online searching a powerful aid.

## SEARCH RESULTS

Following execution of the constructed search strategy, records can be printed in a variety of formats, usually including basic bibliographic information (author, title, source, etc.), the descriptors assigned as index terms to the article, and an abstract, which usually summarizes methodology, results, and conclusions. Customized output formats are also possible and can be controlled by users.

**Our best to you!**



**Merry  
CHRISTMAS**



**TURFGRASS INC.**





G C S A A • 89

# International Golf Course Conference & Show

February 6-13, 1989

Anaheim Convention Center, Anaheim, California

*60<sup>th</sup>  
Anniversary*

- **Trade Show**
- **Golf Championships**
- **33 Seminars**
- **Annual Meeting**

For conference, seminar or exhibitor information, call  
800/472-7878 or 913/841-2240



Golf Course Superintendents  
Association of America  
1617 St. Andrews Drive  
Lawrence, KS 66046-9990



# Rock Irons, Roller Bases and Harsh Reality

by JAMES A. LATHAM  
Director, Great Lakes Region, USGA Green Section

The 1988 season is one of great challenge throughout the Great Lakes Region, mostly dealing with water (or lack of it) and water management (or lack of it). Early on, an unfortunate few courses relearned the vicious nature of crystalline water associated with ice sheet damage or freeze/thaw problems which caused winterkill of *Poa Annua*. Not too long after the damage became evident, the pattern was set - this was NOT to be wet season. Few folks missed the opportunity in May to let courses dry down to suppress the vigor of *Poa Annua*. There was no warm, spring rain to get things started, though, and stolon growth on greens was slow to develop.

Irrigation became an all-encompassing chore at all but a handful of courses and water was applied with reckless abandon during the two or three months of southwestern weather we enjoyed. High evapotranspiration kept the pumps going and the sale of hose and rollerbase sprinklers reached an all-time high. Where an adequate supply of water was at hand and where there were enough hands to supplement irrigation systems, things couldn't have been better. Fungicide inventories gathered dust and trade-ins were being discussed . . . until the last week of July or the first week in August.

What hit the fan then was normal Midwestern weather - humidity and continuing heat. All of a sudden the applied water didn't go away. It hung around in the soil or thatch to act like a heat exchange out of commission. It kept absorbing daytime heat to keep things cozy at night. The outward re-radiation of heat at night was reduced and our temporary desert climate was replaced by a sauna. The fungicide folks were slovent again. *Poa Annua* began to make its summer trip south, which is really unfair after all the water that had been poured on to keep it alive for two months. Reality returned.

About then, I wondered why we spend so much time, money and effort on the control of *Poa Annua*, but when it goes away without any help why do spend so much time, money and effort to replace P.a. at the inopportune time that it departs? Or is it a demand by golfers that green is the only acceptable color, no matter what? Hopefully, Green Committee people recognized that all things in nature are beyond the total control of people and despite our most up-to-date practices, some plants just sicken and die. And rather than becoming paranoid about losses they will remain content with the turf that was saved. The spread of bentgrass in fairways did keep on keeping on - with less competition, so there was a bright side to the P.a. losses.

The true unfortunates this year are those whose water supply ran out, was cut off or perhaps worse yet, those whose water supply went bad. The contamination will have a prolonged effect on the soil. This did happen to courses in Canton, Illinois with sudden salt buildup and in Big Sky, Montana where the sewage effluent used for irrigation became a cause of turf deterioration. Both of these cases are reminders to have water analyses done every couple of years to track the condition of irrigation water. Had it not been for Brad Anderson's annual check at Canton, it is likely that the sudden rise in salinity would have gone unchecked until the turf and trees were dead or severely damaged.

Water woes invoke the inevitable comments about poor drainage. Continued observations prove that greens built under exact Green Section specifications continue to perform admirably. Laboratory determinations continue to show that many peats are unfit for use with sands acceptable for putting green use because they have too much silt and/or clay in them. Like water, topdressing mixes should be checked periodically.

Incidentally, the USGA session at the North Central Turf Expo at Pheasant Run will feature all of the facets of Master Planning plus a description of the total renovation of the North Course at Detroit Golf Club this fall, by Superintendent Clem Wolfrom. Superintendents who are interested in course improvement should encourage their Committee Chairman to attend this morning session on Tuesday, December 6.

Localized Dry Spots (L.D.S.) were prevalent again this year in sandy mixtures - even on one new Wisconsin green in April, before it had ever been mowed. L.D.S. were also prevalent on a set of Wisconsin greens that had never seen sand or much topdressing of any sort, with a two inch thatch under the playing surface.

This brings us back to Rock Irons. There is a nice little course near the headwaters of the Missouri River, where the largest selling item in the golf shop are Rock Irons. The fairways are so stony that no one wants to break their new clubs - so they buy used 4, 5 and 6 irons in the worst areas. If they break 'em they just throw away the pieces and get another. That course, by the way, has a very active caddy program based on the Western Golf Association setup that is doing exceptionally well. How many 9-hole courses have 12 fully-qualified Class A caddies available?

One final note on quality at the end a very stressful

CONTINUED PAGE 17

# SPECIFY THE BEST FOR YOUR GOLF COURSE

## Warren's® TerraBond™

### PUTTING GREEN CONSTRUCTION

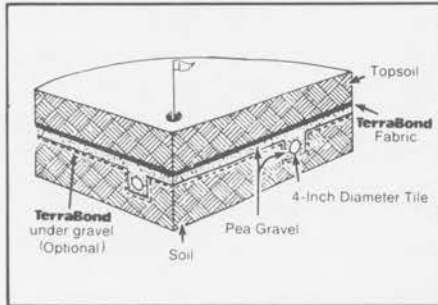

Use TerraBond as a replacement for the usual 2" coarse sand layer between the greens mix and the gravel drainfield. The fabric will eliminate downward migration of the mix into the gravel and the subsequent reduction of water flow from the green.

TerraBond's high water permeability and highly engineered uniform density and EOS (AOS) make it an ideal fabric for this use. It will not rot in the soil-water environment. Its horizontal (planar) flow characteristic moves excess water horizontally out to the sides.

### SANDTRAP LINING

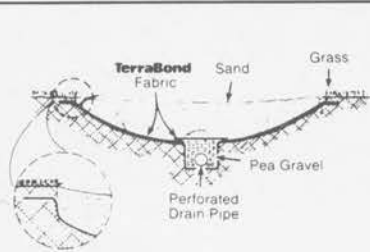

Line the entire golf sand trap with TerraBond, including 6" under the surrounding sod. The sod's roots will knit the fabric to the soil beneath. Clay and rocks will be totally restricted from moving up into the sand.

Sand wash-down in rainstorms will be dramatically reduced, because TerraBond interrupts the interface of sand/soil. Rakeup will be greatly reduced. Time will be saved. Also, "wrap the gravel" in the trap drain to keep it flowing indefinitely. TerraBond's polyester will resist chemical and ultraviolet degradation.

### SLOPE EROSION CONTROL

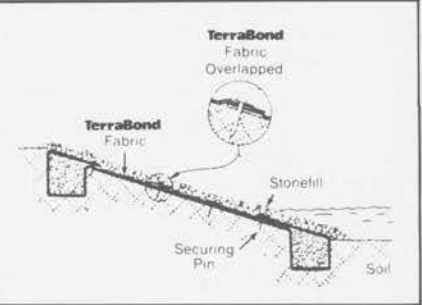

TerraBond is utilized beneath cut slope stone protection (rip-rap) as shown above. The fabric provides long-term confinement of cut slope or fill material.

Being constructed of soft and pliable needle-punched polyester, TerraBond will remain stable and functional for many years, in spite of potential exposure to the sun's ultraviolet rays and/or concentrated hydrocarbons such as gasoline, diesel fuel, oil or hydraulic fluid.

**TerraBond also can be used in weed control, gravel path construction, retaining wall filtration, subsurface drainage, patio construction and planter filtration/separation.**

**Warren's®  
TerraShield™**  
Polyester † Geotextile Ground Covering

... the best greens **BLANKET**  
in the business.

**THE  
EXPERTS  
AGREE**

**Winter 1984-1985 Wind Desiccation Damage Test on bentgrass greens**  
(Univ. of Nebraska-Test compared the protection of TerraShield cover with clear plastic cover and uncovered control area.)

- Desiccation injury around test site was severe. Uncovered control area had 60% damage. TerraShield covered area had no injuries. Control area produced only 36% of the green cover obtained under TerraShield blanket.
- Green-up occurred 24 days earlier with TerraShield . . . and remained significantly greener than the uncovered control area for 21 days after cover was removed.
- TerraShield produced 3 times the recuperative potential of the control area . . . and twice that of clear plastic covered area.
- TerraShield enhanced soil temperature compared to uncovered control area.
- TerraShield remained in place all winter with no ripping or tearing despite heavy winds.

**\*CALL FOR MORE INFORMATION, SAMPLES, AND WHOLESALE PRICING.**

**GENTURY RAIN AID**

31691 Dequindre  
Madison Heights, MI 48071  
313-588-2992

22159 Telegraph  
Southfield, MI 48034  
313-358-2994

3400 Jefferson, S.E.  
Grand Rapids, MI 49508  
313-452-3373

CALL TOLL FREE number MICHIGAN 1-800-544-9219

# GETTING ORGANIZED: HOW TO SCHEDULE YOUR DAY

If your workload keeps growing as fast as your workday seems to shrink, maybe your problem is a lack of organization.

A few minutes spent in planning can help you get more accomplished each day and help you run your operation more efficiently. Not everyone can be an efficiency expert, but even the most disorganized person can get more done by planning his work more efficiently. These eight suggestions can help.

1. At the end of each workday, take a few minutes to schedule the next day's activities - phone calls, meetings, interviews, and projects. Make a list, with the most important things to be accomplished at top. As other important things come up, you may have to change your plans, but having a list can help you keep your priorities in mind.

2. Schedule work according to your own personal efficiency. Not everyone works at peak efficiency first thing in the morning, so you should schedule the important things for a time when you are at your sharpest.

3. Decide whether you would rather tackle the tough projects first and get them out of the way, or ease into them by finishing the smaller tasks first.

4. Tough problems take concentration, and it is

impossible to concentrate when you are continually interrupted. If you know you are going to have to deal with a thorny problem, set aside some time for it. Let everyone know that you don't want to be disturbed and make yourself work at it.

5. Use an action request form for assigning tasks to your subordinates. It should include a description of the job, a deadline, and a person responsible for its completion. This system makes for more paperwork, but it does make assigning jobs easier and gives you a written record for reference.

6. Take close look at the things that make up your day. Some of them may be merely habit and no longer necessary. Cut ruthlessly. A collection of minor tasks can take valuable time away from important duties.

7. Group similar tasks into one time period. If you have to do similar things at different times during the day, try doing them all at once. Switching your concentration from one job to another can take more time than you think.

8. Don't agonize over decisions. There is a difference between spending a reasonable amount of time considering alternatives and delaying a decision

CONTINUED PAGE 17

## TREE TRANSPLANTING

LARGE TREES UP TO 11" DIAMETER

**ARMSTRONG**

*LAWN AND TREE, INC.*



"YOUR EVERGREENS SHOULD BE MOVED NOW."

44275 Whithorn  
Sterling Heights, Michigan 48078

731-5550  
264-8803



**BILLY  
GOAT**  
INDUSTRIES, INC.

# GET A GOAT

"FROM THE CLEAN-UP SPECIALIST"



Briggs & Stratton  
& Kawasaki Engines

Prices start at \$299.95

## 3 H.P. to 11 H.P.: Blowers that work up a storm!

### TRUCK LOADERS

- 5 H.P. to 11 H.P.

Prices start at \$1069.00



### VACUUMS

- 3.5 H.P. to 11 H.P.

Prices start at \$499.00



**MOWER SALES, INC.**

For Information or Demonstration,  
Call Bob Cluff or Ed Stesny,  
Turf Manager at:  
(313) 541-4660

**RANSOMES**  
**BOB-CAT®**

**Tired of the high cost of maintaining your vehicles?  
CHECK OUT THE HIJET!**



- \* Cut-a-way
- \* Full cab with guard bars
- \* Full cab with steel doors
- \* Tipper with full cab and guard bars
- \* Tipper with full cab and steel doors
- \* Lift pick tipper with steel doors
- \* People mover
- \* Security patrol unit

## **PFEIFFER L/M DAIHATSU**

**2424 28th Street, S.E.  
Grand Rapids, MI 49508**

**Tom Elliott  
(616) 949-7800**

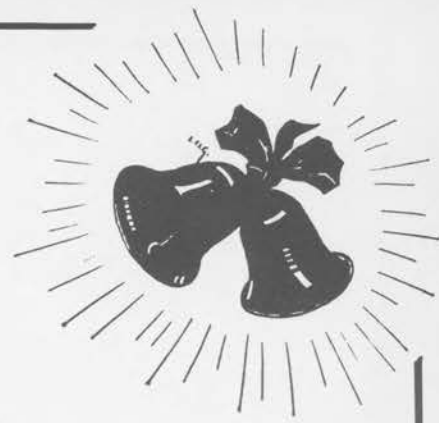

*Happy*  
HOLIDAYS

EVANS MINING CORPORATION



GREAT LAKES MINERALS, CORP.

1900 RICHMAN ROAD — SMITH'S CREEK, MICHIGAN 48074  
1-800-332-3294 367-3021



Model PAL  
Aerial Lift/Trailer (top)

Model 400  
Log & Brush Chipper (center)

Model R-18  
Stump & Root Grinder (bottom)



Full vision cutting. 22" wide.  
Hydrostatic drive.



6" capacity. Hydraulic tilt dump.  
8½ cubic yards.



6" capacity. 360° discharge.  
Self feeding.



Self-propelled. Positive clutch.  
Cuts 20" deep.



Working heights to 40 ft.  
Removable in 5 minutes.



12" capacity. 360° feed rotation.

# PROMARK.

## Everything for tree-related grounds maintenance.

For aerial lifts that reach up to 40 feet for tree and utility service work, to rugged stump grinders that eliminate roots down to 20" below ground, Promark provides landscapers, arborists and grounds maintenance professionals with a complete family of equipment.

Making up the strong center of the line are Promark's brush chippers and log splitters, in a range of sturdy models that make finishing a job easy and profitable.

Call   
**731-7240**

# WEINGARTZ

"WE SERVICE WHAT WE SELL"

46061 VAN DYKE, ½ Mile North of M-59, UTICA

HOURS: Mon. 8:30-8

Tues.-Fri. 8:30-5:30; Sat. 8:30-5

MICHIGAN'S LARGEST LAWN & OUTDOOR POWER EQUIPMENT DEALER

Since  
1945



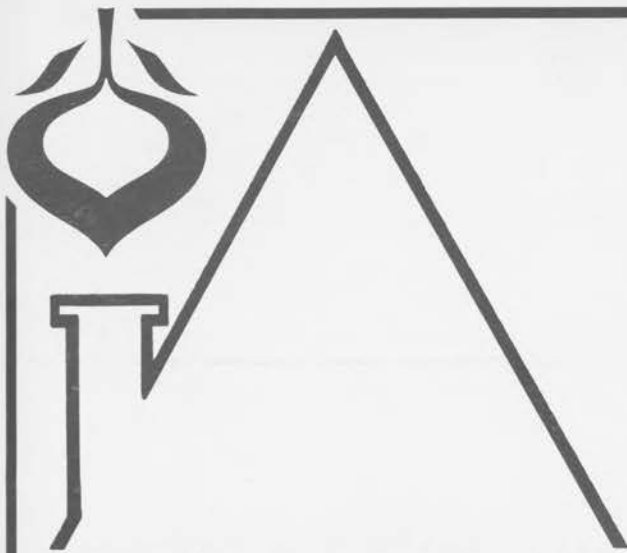

**Shemin Nurseries, Inc.**  
*Everything Under One Roof*

-  CHEMICALS
-  NURSERY
-  TOOLS
-  FERTILIZERS
-  GRASS SEED
-  IRRIGATION
-  POWER
-  EQUIPMENT
-  TERRA COTTA

*Prompt, Efficient  
Delivery*

**Our Standard  
is Excellence**

**Check Our Prices**



Shemin Nurseries, Inc.  
6900 Pardee Rd.  
Taylor, MI 48180  
313-291-1200

#### A POEM

I planted grass into the ground.  
It thrived, and grew by leaps and bounds.  
My fairways, they looked really swell;  
The greens, the tees - they all did well.  
But ALAS - it's here - that dreaded scum -  
The thing that we call pythium!!  
The blue, the bent, of course the rye -  
I'm sure that now they all will die.  
We spray and spray, and spray some more,  
The water system works no more.  
Equipment groans but trudges on  
Even though the Poa's gone.  
The thunderstorms keep rolling in,  
WAIT! Yes, here comes the hail again.  
The rivers arise, the creeks all flood,  
The course is lost in tons of mud.  
The stag was cancelled yesterday,  
Just one guy showed up to play.  
Don't fret or cry, be brave and strong,  
Summer doesn't last too long.  
The days are short, the nights - they cool,  
Leagues are over, they've closed the pool.  
And finally, I can sleep at night  
To dream of when I'll win this fight.  
Chin up!! my friends, don't be so sad,  
It really isn't all that bad.  
When things look tough and really bleak  
OOPS!! I have to go - another leak.

Robert J. Hall

---

#### ROCK IRONS, CONT.

summer. The Chairman of the USGA Senior Amateur Championship Committee told the contestants at the contestants dinner September 19, that the Milwaukee Country Club was only the second course in his 28 (or 38) years of attending championships, which required no white paint. The only directive that the USGA's Tom Meeks gave to Superintendent Danny Quast was "Don't Change Anything!"

And that was "The Summer of '88." Some good, more bad. As we improve our understanding of water management under the environmental and cultural stresses to which golf turf is subjected, we will be better able to cope with similar problems in the future.

---

#### GETTING ORGANIZED, CONT.

because it is an uncomfortable one.

If you have to make a decision, make it, the only way you can avoid making a decision is by waiting until you have only one alternative remaining. The last alternative may be the worst of the bunch.

These eight suggestions may not make you an efficiency expert, but they may help you reevaluate your work habits. Not everyone works the same way, but it is important to find a system that works for you. Set your own schedule and follow it. You will be surprised at how much you can accomplish.

Credit: Fore Front

If you have changed your address, please let us know so we can keep our addressing plates up to date.

**Present Address:**

NAME

ADDRESS

CITY STATE ZIP

**Fill In New Address:**

NAME

ADDRESS

CITY STATE ZIP

Mail this form to:

**A PATCH OF GREEN**

31823 Utica Road  
Fraser, Michigan 48026

MIDWEST REGIONAL TURF CONFERENCE

January 23-25, 1989

Adams-Mark Hotel, Indianapolis, Indiana

Jo Horn - (317) 494-8039

*Holiday*

*Greetings*

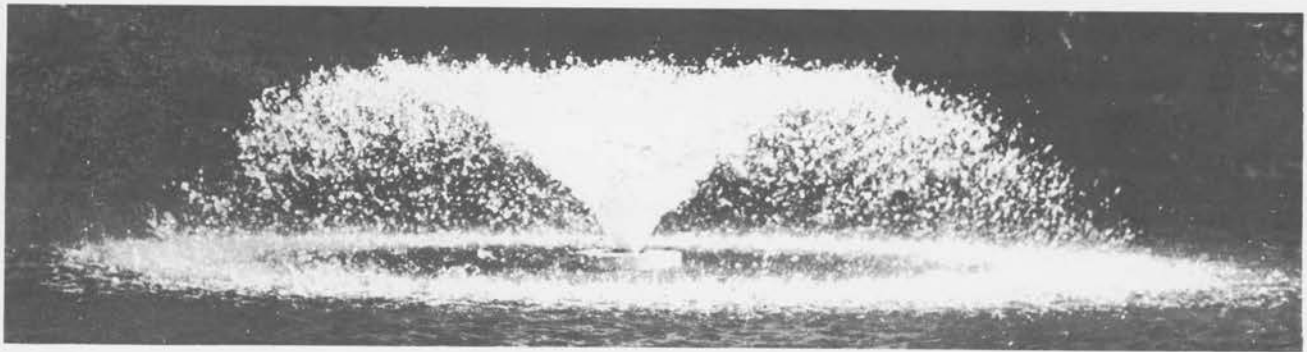

**OTTERBINE DECORATIVE FOUNTAINS**

OTTERBINE Aerators can help you keep unsightly algae growth and objectionable odors under control naturally. The fact that OTTERBINES also create beauty - is just one of the many benefits of using our Spray Sculpture Floating Fountains. We create beauty while solving problems. **LIGHTING AVAILABLE FOR DRAMATIC NIGHTTIME BEAUTIFICATION**

**CALL TOLL FREE 1 - 800 - 544 - 9219**

**CENTURY RAIN AID**

31691 Dequindre  
Madison Hts., MI 48071  
**313/588-2992**

22159 Telegraph  
Southfield, MI 48034  
**313/358-2994**

3400 Jefferson S.E.  
Grand Rapids, MI 49508  
**616/452-3373**

---

CHI CHI RODRIGUEZ TO RECEIVE THE OLD  
TOM MORRIS AWARD

---

Juan "Chi Chi" Rodriguez, a superstar on the Senior Tour, has been selected to receive the Old Tom Morris Award from the Golf Course Superintendents Association of America (GCSAA). Rodriguez is the seventh recipient of the award, one of golf's most prestigious.

The award will be presented to Rodriguez on February 13, at the banquet closing GCSAA's 60th International Golf Course Conference and Trade Show, which begins February 6, in Anaheim. More than 2,000 people are expected to attend the banquet including dignitaries from every major golf association.

GCSAA President John A. Segui, CGCS, said, "Mr. Rodriguez has truly demonstrated the characteristics so commonly associated with Old Tom Morris. He has dedicated his life to promoting the game, but more so, he has dedicated his life to helping his fellow man."

Rodriguez joins Arnold Palmer, Bob Hope, Gerald Ford, Patty Berg, Robert Trent Jones, Sr. and Gene Sarazen as recipients of the coveted honor.

The Old Tom Morris recipient is nominated and selected by the GCSAA Board of Directors.

## A NEW MEMBER

I am a new member.

I see you at the meetings, but you  
never say "Hello",  
You're busy all the time you're there,  
With those you already know.

I sit among the members,  
But I'm a lonesome guy,  
The new ones are as strange as I,  
And the old ones pass me by.

But - darn it! You folks asked me in,  
And talked about fellowship,  
You could have stepped across the room,  
But you never made the trip.

Why don't you nod and say hello,  
Or stop and shake my hand?  
Then go and sit among your friends,  
Now that I'll understand.

I'll be at your next meeting,  
A nice time I hope to spend,  
Do you think you could introduce yourself?  
I'd like to be your FRIEND.



**TORO**

# The No. 1 name in golf course irrigation.



It's no coincidence that the country's top golf courses use TORO irrigation systems. Because there are more TORO systems installed on golf courses than any other kind. For a number of very good reasons.



**WILKIE**

**Turf Equipment Division, Inc.**



1050 OPDYKE RD. • P.O. BOX 749 • PONTIAC, MICHIGAN 48056 • (313) 373-8800

# OVERSEED TO COMPETE WITH POA ANNUA?

by Dr. A. Douglas Brede  
Research Director, Jacklin Seed Company,  
Post Falls, ID

Presented at the 41st Northwest Turfgrass Association  
Salishan Lodge, Oregon  
September 21-25, 1987

Sometimes even the best cared for turf can turn bad. In spite of careful irrigation, mowing, traffic control, fertilization, and pest control, turf can sometimes deteriorate to the point where a decision is needed: Does the expense of maintaining a deteriorating turf out-weigh the expense of replanting? Today, with renovation chemicals available such as Roundup, methyl bromide, or plant growth regulators, it is easier than ever to make the decision to renovate. Moreover, renovation is much simpler than tillage. Regrading, rock picking, and even transit leveling are often required following tillage. This adds to the expense and bother in renewing a lawn, and were major objections to renovation in the past.

Renovation today is surprisingly simple. Numerous trade magazine articles describe the chemicals and methods of successful renovation. Renovation of an average home lawn can be done often in less than a day. The homeowner can be mowing the new lawn in a matter of weeks.

Throughout the humid Northwest, a major reason for turf renovation is *Poa Annu*a (annual bluegrass). Geographical areas with high rainfall coupled with mild winters and summers are usually plagued with *Poa*. *Poa* becomes established because the growth conditions in the lawn make *Poa* more competitive than the desired lawngrass species. Put more directly, *Poa* can literally grow faster than other lawngrasses under our conditions.

Throughout my research career, I've had the opportunity to study *Poa* from three different geographical locations: Pennsylvania (cool, humid), Oklahoma (warm, dry), and Idaho (cool, dry). Each location has its own unique problems and solutions with *Poa*. To date, no one has solved the *Poa* problem. But by understanding how *Poa* competes with other grasses, the informed turf manager can make decisions that will help minimize *Poa* problems in his turf.

Plants compete for three basic requisites of life: sunlight, soil nutrients, and water. A plant that can get one of the three requisites faster or better than the other will survive. Obviously this is a simplistic view of plant interaction (since other factors such as mowing, compaction, wear, etc. come into play), but the bottom line for plants is which one gets to the "food" first. Our management regimes effect the

relative health and vigor of our lawngrasses and may make a competing weed more suited to seeking "food."

A few years ago I developed a specialized research technique by which seedling research could be readily accomplished. The mechanics of this technique are not important for purposes of this discussion. However, the implications of the technique were that turf seedlings could be essentially stuck in place on a seedling with no lateral movement. This opened the door for critical studies on how one plant responds over time to competition from its neighbors.

Using this technique, we studied seedling plant interaction on an acute scale. We examined plant competition from three standpoints:

1. **Sod Seeding** - planting seed into a stand of existing turf. Holes were punched in mature sod: the holes were filled with sterile soil and planted to a test species; the sod represented the competing species. A wire ring delineated the microplot from the surrounding sod. Germination and growth were monitored over time, usually for 3 to 6 months.

2. **Simultaneous seeding** - competing species sown on a sterile seedbed adjacent to one another. Usually we planted the test species in 1 inch circles within areas seeded to a competitor. Seeding rates of the test species and competitor could be varied in different plots to determine the effect of population density on competition. Wire circles were again used for demarcation of plots.

3. **Spaced planting** - different species sown spaced apart to determine their growth potential. We usually planted 20 seeds into 1 inch circles spaced 6 inches apart on a sterile seedbed. The ultimate growth potential was estimated by the tillering rate over time. Grasses that tillered fast were regarded as potentially good competitors. These tests usually remained in study for 6 weeks.

Most of our overseeding tests have been confined to Kentucky bluegrass, perennial ryegrass, and annual bluegrass, although we've done a little work with a few other species. Without question, perennial rye-

CONTINUED PAGE 22

Nothing Runs Like a Deere®

# JOHN DEERE COMPACT DIESELS

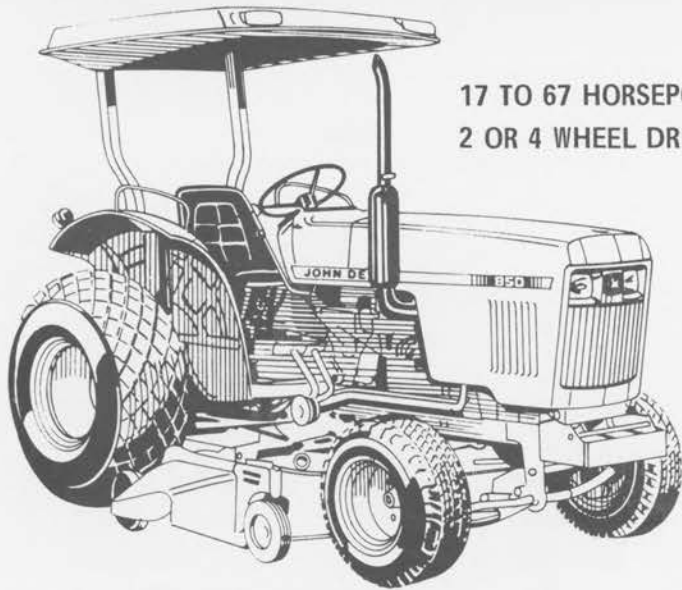

17 TO 67 HORSEPOWER  
2 OR 4 WHEEL DRIVE

John Deere compact diesels come in eight models, so you can match horsepower to your needs. All are packed with performance features that make them small giants on any big

## JOHN DEERE FRONT MOWERS

*The most  
versatile equipment a  
groundskeeper can own*

- Mowers 50 to 76 inches
- Snow Blowers
- Front Blades & Brooms
- Vacuum Attachments  
& Cabs Available
- Gas or Diesel Engines

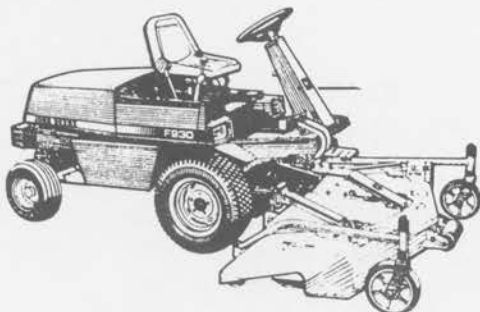

52 INCH —  
2 YEAR WARRANTY

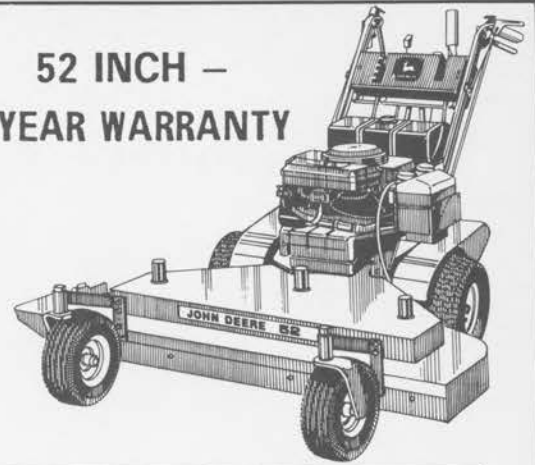

**Panther**  **Sales**

2274 TELEGRAPH, BLOOMFIELD HILLS

**Phone 335-5149**

SUMMER HOURS — MAY 1  
MONDAY-FRIDAY 8-7 SATURDAY 8-12

job. More than 50 capacity-matched attachments are available to keep the tractor you buy busy the year round. See us for a test drive soon.

## New John Deere AMT 600. It's almost a truck.



There's nothing else like it! Our new All Materials Transport gives you true hauling ability. Not just travel. Takes loads up to 600 pounds on flat land, up to 400 in hills. Dumps them, too. Goes places a truck can't.

Unique 5-wheel stability and 4-wheel differential lock traction. 341 cc engine and 62:1 torque ratio transmission for pulling power. With no gears to shift. Spring-loaded front fork cushioning. Low compaction. Anti-skid features.

**GIVE US A CALL AND WE'LL DROP ONE OFF  
FOR YOU TO USE FOR A DAY!**

Introducing a  
new benefit  
from Chipco® 26019...  
convenient  
Chipco® 26019 FLO



**RHÔNE-POULENC INC.**  
AGROCHEMICAL DIVISION



**ROBERT P. DUGAN**  
SALES REPRESENTATIVE - SPECIALTY  
P.O. BOX 398  
ROMULUS, MICHIGAN 48174-0398  
(313) 753-3392

**OVERSEED?, CONT.**

grass was easiest to overseed. Perennial ryegrass seedlings have a high vertical growth rate. On several occasions we saw leaves of perennial ryegrass protruding above the sod. This vertical growth habit allowed ryegrass to obtain light when other grasses withered and died in the dense shade of neighboring plants.

Here are some other important findings from this series of overseeding studies:

1. Perennial ryegrass was followed in competitive ability by annual bluegrass. Kentucky bluegrass was a distant third in the competition.

CONTINUED NEXT COLUMN

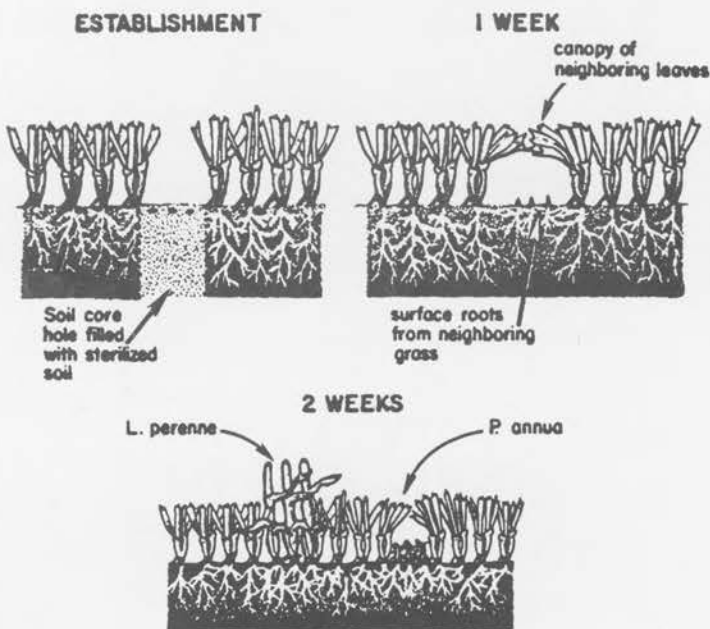

**SOD SEEDING - @6 WKS.**

Seed	Seedlings	Tillers
Ryegrass	12	3
Poa annua	7	2
Ky. Blue	4	1

Sod Species Unimportant

**HEAVY DOLLARSPOT AND  
RED THREAD DISEASE**

	Severity
Pure Ryegrass	20%
50-50 Mix	5%
Pure Ky. Blue	18%

"For Land's Sake 'Use Peat'"



**OXFORD PEAT CO.**

1430 E. Drahter Rd.  
Oxford, Michigan 48051

PROCESSED PEAT  
Custom Mixes

FRED LATTA • 313/628-5991



**Tire Wholesalers  
Company, Inc.**

Phone: (313) 354-5644

19240 West Eight Mile Southfield, MI 48075  
(½ Mile West of Southfield Road)

TRUCK - CAR, MOTORCYCLE,  
FARM, TRAILER, INDUSTRIAL  
TIRES & TUBES

Pirelli



Carlisle



LAWN & GARDEN EQUIPMENT TIRES

## LESCO Greensmower designed by and for today's turf professionals

- 18 H.P. twin-cylinder Kohler Magnum engine for added power and long life.
- Hydraulic power steering for easy maneuverability
- Independent reel controls for multiple mowing patterns
- Reversible hydraulics to allow backlapping of individual cutting units while on machine
- Center post steering for added safety and ease in climbing on and off either side of machine
- Rocker foot pedal for raising and lowering cutting units
- Automatic starting and stopping of reels

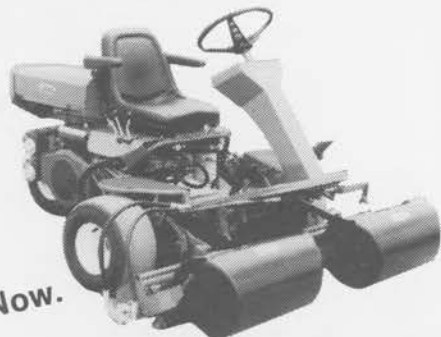

Order Now.

(800) 321-5325  
NATIONWIDE

**LESCO**

(800) 362-7413  
IN OHIO

LESCO, Inc. • 20005 Lake Road, Rocky River, Ohio 44116 • (216) 333-9250

2. The species of the sod into which seeds were planted was generally unimportant. Ryegrass could be seeded into Poa sod as readily as into Kentucky bluegrass sod. Although there was a slight tendency for ryegrass sod to be the toughest competitor against ryegrass seedling (i.e., likes repel).

3. Anything you can do to disturb the existing sod will benefit the overseeded seedlings. Of course Roundup treatment of the sod prior to overseeding is ideal. But if this is not possible, try scalping or heavily verticutting (dethatching) just prior to overseeding. This will weaken the sod and give the seedlings their best chance. Trade journal articles have even described the use of plant growth regulators to suppress the sod in advance of overseeding.

4. Season of planting is important. Poa grows best during early spring and early fall. Overseeding at other times of the year will stretch the grass-to-Poa ratio in favor of the grass. Mid summer establishment favored ryegrass over Poa by a large amount, because Poa likes lower temperatures and because Poa "had its mind on other things" during that time - it wanted to go to flower. Poa germinating during June and July has the impulse to go to flower rather than growing vegetatively. That weakens it as a competitor.

5. Choosing the best variety and seedlot is important. A weak or unplanted variety will not be a good competitor in the seedbed or a good turf in the long run. Likewise, a seedlot with low germination rate is weak and will not be a good competitor.

With Kentucky bluegrass, varietal selection is very important in overseeding. Varieties that perform the best nationally don't always perform the best in our unique Northwest climate. Top Oregon varieties are Eclipse, Majestic, Columbia, Challenger and Summit (Nallo). Top Washington varieties are Classic, Midnight, Haga, Mona and Summit. Top Idaho varieties are Ram I, Bristol, Midnight, Challenger and Summit (data source: 1980-85 National Test Trials). Ryegrass variety is slight less important than bluegrass variety in overseeding, but it is important for a nice, attractive appearance to the mature turf. All\*Star, Palmer, and Gator are excellent ryegrasses for the Northwest.

### 59th ANNUAL MICHIGAN TURFGRASS CONFERENCE

JANUARY 16-18, 1989

Clarion Hotel and

Conference Center, Lansing, Michigan

Contact: Michael Saffel

Department of Crop and Soil Sciences

Michigan State University

East Lansing, Michigan 48824

(517) 355-9022

Search sets are generally sorted by first-named author, though many other options are possible.

### SERVICES OFFERED BY TIC

1. **Searching:** To have TIC personnel construct and execute a search, call or write the Center. Search results will be printed and mailed, normally within 48 hours.

2. **Document Delivery:** If a citation produced by a search contains an MSU Call Number within the record, a photocopy of the article can normally be sent out within a 48 hour period. (Limited single copies provided for private study, scholarship, or research only; if a user makes a request for, or later uses, a photocopy or reproduction for purposes in excess of "fair use," that user may be liable for copyright infringement.)

3. **Dial-up Access:** If you are interested in becoming a subscriber and searching the database remotely, please contact TIC to receive the necessary technical details and registration forms. Dial-up access will be supported for most IBM or PC-compatible systems running under PC or MS-DOS with a 1200 or 2400

baud auto-dial Hayes-compatible modem and the necessary terminal emulation software. An electronic mail and bulletin board system will also be supported for communications between dial-up users and TIC at MSU. Documentation to guide search strategy construction, control output formats, and download records will be included in the subscription dial-up service. The computer will be available for access 18 hours a day, 7 days a week beginning August 1, 1988.

4. **Service Fees:** Write or call TIC to receive a complete fee schedule.

### WHAT THE TURFGRASS INFORMATION CENTER DOES

Acquire and hold materials relevant to turfgrass research, professional training, and turf management.

Index and Abstract materials for inclusion in the online file, including the development of **Turfgrass Thesaurus** to guide indexing and searching. The Thesaurus currently contains over 12,000 terms and details interrelationships between useful search key-

CONTINUED PAGE 26

# The No. 1 name in golf course irrigation.

## The right amount of water

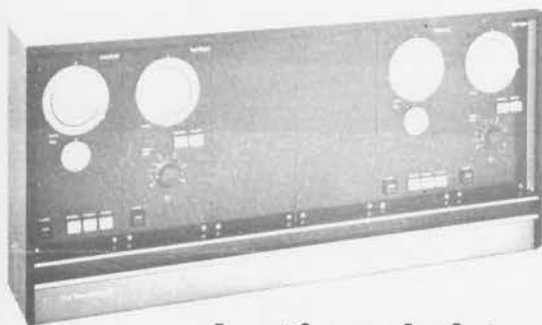

## In the right place



## At the right time



**WILKIE**

**Turf Equipment Division, Inc.**



1050 OPDYKE RD. • P.O. BOX 749 • PONTIAC, MICHIGAN 48056 • (313) 373-8800



# Country Club Greens Grade Fertilizers

Gold Cup quality for great-looking  
greens, tees & fairways.



- Small Homogeneous Granulation
- Less Mower Pick-up
- High Methylene Ureas (W.I.N.)
- Four Unique Formulations
  - 18-4-10 90% Org.
  - 8-4-24 30% Org.
  - 18-3-12 70% Org.
  - 18-0-18 80% Org.

GREAT ON FAIRWAYS EVEN AT LOWER  
RATES WON'T SPECKLE LIKE BLENDS

**Lebanon**  
TOTAL TURF CARE

1-800-233-0628

GREEN, CONT.

lawnmower, having its start as early as 1830, was slowly adopted for horsedrawn use and special leather shoes were placed on the horses so the golfing surface would not be disturbed.

Now two explosions lie just ahead for golf in America. The first occurred in 1913 when an unknown American caddy by the name of Francis Ouimet beat the world's greatest golfers of the day, Englishmen Vardon and Ray for the U.S. Open Championship at The Country Club, Brookline, Massachusetts. The popularity of the game soared. About the same time, agricultural science had budded and was about to bloom. The USGA, organized in 1894, supported publication of a new book in 1917, "Turf for Golf Courses" written by Drs. Piper and Oakley of the Department of Agriculture. These men were not only scientists but golfers as well. Others throughout the country who loved the game could see the need for better, more dependable playing surfaces. Agricultural science would now serve golf.

The Green Section of the USGA was formed in November, 1920 and gained immediate support from green chairmen and greenkeepers (now they prefer to be called golf course superintendents) throughout the country. It's difficult for us today to even imagine or understand the complaints of the golfer just 40 years ago! For example, earthworms were a major problem especially on greens. Either their casts or their bodies were always in the line of a putt. One early Green Section agronomist recalls the golfers would complain bitterly that their ball would invariably be deflected away from the hole while putting over these impediments. In all his years however, he never once heard a golfer complain that his ball was deflected into the hole by the earthworm. Surely, the scientist thought, statistically this must have happened at least now and then!

Disease was the big grass killer of those days and Dr. John Monteith, then Director of the Green Section, in the late 1920's developed the first effective fungicides for their control. His findings are still in use today.

The march of science made possible new machinery, new grasses, chemical fertilizers, weed controls, insecticides, improved soil mixes, irrigation and drainage principles, etc. All followed in blazing succession from the early 1930's to the present day.

Dr. Fanny Fern Davis received the 1975 USGA Green Section Award for her tremendous contribution to golf through work with turfgrasses. During World War II, Dr. Davis left her job with the National Capital Parks Service and served as Acting Director of the USGA Green Section. During this time, she was instrumental in recognizing and adapting newly developed chemical plant hormones for the control of broadleaf weeds in turf. If you have ever played golf in a sea of dandelion seedheads, you will recognize immediately the importance of her work with 2,4,D. She ushered in a new era for the game. Dr. Davis' contribution in weed control has had far-reaching effects and she is the first woman to receive the Green Section Award.

## D & C Distributors

51000 Grand River Wixom, Michigan 48096  
(313-349-7779) (800-888-7779)

Michigan's Only Stocking Dealer  
For  
R & R PRODUCTS

### QUALITY REPLACEMENT PARTS

TORO	JACOBSEN	HAHN-WESTPOINT	CUSHMAN
RYAN	ROSEMAN	RANSOMES	MOTT
NATIONAL	YAZOO	FORD	EXCEL
	REEL SHARPENING COMPOUND		

CALL US TOLL FREE

800-888-7779

FOR YOUR SUPPLY ITEMS  
FLAGS — POLES — RAKES — CUPS

WE ARE RICO MFG. ONLY DISTRIBUTORS FOR  
MICHIGAN, OHIO, INDIANA AND ILLINOIS

EXCELLENT QUALITY PERSONALIZED TUBE FLAGS  
SOLID FIBERGLASS POLES WITH SOLID IMPREGNATED COLOR  
FIBERGLASS RAKE HANDLE, FOAM FILLED TO FLOAT  
14" or 22" RAKE HEAD  
PUTTING GREEN FLAGS AND POLES - CUPS

WE ALSO HANDLE LEWIS AND PAR AIDE  
REPLACEMENT SEATS FOR GOLF CARTS...TRACTORS...ETC.

**INFORMATION FILE, CONT.**

words. It will be available for distribution in 1988 to aid search strategy construction, and is also available online alongside TGIF.

**Facilitate Access** by searching the database, providing the printed bibliography resulting from a search, and supporting remote searching.

**Document Delivery** by providing access to source documents held in the MSU Libraries.

**HOW YOU CAN HELP**

Contribute materials written, edited, or distributed by yourself or your institution/agency/association/corporation. The more information processed by the Center, the more that is available online. Put us on your mailing list, and send us your publications.

Become a subscriber! Support the total access to the turf literature for all Turfdom.

**BEFORE YOU CALL**

Identify your topic concisely, and inventory syno-

nyms, acronyms, or closely-related terms to help in search construction.

**WHO TO CONTACT:**

USGA Turfgrass Information File  
Turfgrass Information Center  
Library W-212  
Michigan State University  
East Lansing, Michigan 48824-1048  
(517) 353-7209  
8 am - 5 pm EST  
MON. - FRI.

**SUPERINTENDENT AND ASSISTANT SUPERINTENDENT**

**INDIANWOOD GOLF AND COUNTRY CLUB.**  
Must have minimum 2-year degree. Salary is negotiable. Experience is a must. Full benefits offered. Send resume or call Mark Jackson - 1081 Indianwood Lake Orion, Michigan 48035, (313) 693-0006.

LOW COST DAMS  
RETAINER WALLS  
WOOD & STEEL  
VERTICAL INSTALLATION  
BRIDGES  
MINIMAL OR NO DAMAGE TO COURSE  
**american marine  
shore control**

313-673-3320                      313-623-9495

**POND DREDGING SPECIALIST**

Off Road Trucking  
Wide Track Bulldozing  
Shore Line & Land Development  
Grading



**SWEETCO INC.**  
218 Audubon  
South Lyon, Mi. 48178  
**313-437-1830**



—LIME—                      —GYPSUM—

*"Our business is spreading"*

THE MIDWEST'S LEADING CUSTOM APPLICATORS  
OF DRY BULK MATERIALS



**"THE FLOATER"**

**Call for Prices & Availability**

(216) 563-5902 - PETE                      (216) 466-3835 - CHIP

P.O. Box 303                      Rock Creek, OH 44084





Lawn Equipment Service & Sales



151 N. PERRY  
PONTIAC, MICHIGAN 48058  
(313) 858-7700

# Season's Greetings

AND ALL GOOD WISHES FOR  
THE NEW YEAR

# Best Wishes for the Coming Season



**W.F. Miller** Garden & Lawn  
Equipment Company

25125 TRANS-X

NOVI, MICHIGAN 48050

(313) 349-4100

"A Patch of Green"  
31823 UTICA ROAD  
FRASER, MICHIGAN 48026

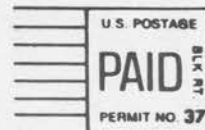

MICHIGAN STATE UNIVERSITY  
LIBRARY-SERIALS  
EAST LANSING, MI 48824